

**INVEREX**

**USER MANUAL**



# General Precautions

1. Before using Inverex, read all instructions and cautionary markings on :  
(1) Inverex (2) the batteries (3) this manual
2. **CAUTION** --To reduce risk of injury, charge only lead-acid rechargeable batteries. Other types of batteries may cause damage and injury.
3. Do not expose Inverex to rain, snow or liquids of any type. Inverex is designed for indoor.
4. Do not disassemble Inverex. Take it to a qualified service center when service or repair is required.
5. **WARNING:** Provide ventilation to outdoors from the battery compartment. The battery enclosure should be designed to prevent accumulation and concentration of hydrogen gas at the top of the compartment.
6. **NEVER** charge a frozen battery.
7. Input/output AC wiring must be no less than 18 AWG gauge copper wire and rated for 75°C or higher. Battery cables must be rated for 75°C or higher and should be no less than 10AWG gauge. The inner diameter of the copper ring terminal which is used to connect battery cables to Inverex DC terminals should be no less than 6mm.
8. Be extra cautious when working with metal tools around batteries. Short-circuiting the batteries could cause an explosion.
9. Read the battery manufacturer's installation and maintenance instructions prior to operating.

# Personnel Precautions

1. Have plenty of fresh water and soap nearby in case battery acid contacts skin, clothing, or eyes.
2. Avoid touching eyes while working near batteries.
3. NEVER smoke or allow a spark or flame in vicinity of a battery.
4. Remove personal metal items such as rings, bracelets, necklaces, and watches when working with batteries. Batteries can produce a short-circuit current high enough to make metal melt, and could cause severe burns.
5. If a remote or automatic generator start system is used, disable the automatic starting circuit or disconnect the generator to prevent accident during servicing.

# Introduction

Inverex is a DC-to-AC inverter with auto line-to-battery transfer and integrated charging system, serving as an extended run UPS, a standalone power source or an automotive inverter.

Inverex supplies power from AC power and DC source. When AC cable is connected to a wall socket, utility power goes to connected equipment(s) and/or charges the battery set via charging system. In UPS mode, Inverex automatically convert battery energy into AC power for backing up the connected devices.

## Features:

- Automatic line-to-battery switchover
- Selectable Input voltage ranges
- High efficient DC-to-AC conversion, minimizing energy loss
- Rack Tower design for flexible placement
- Built-in enhanced charger
- Intelligent 2-stage charger control for efficient charging and preventing overcharge
- Provides overload protection
- Auto restart while AC recovery
- Multi-function LED indications and buzzer alarms

# Operation

## Front Panel Controls and LED Indicators

Shown below are the controls and indicator lights on the front of Inverex.

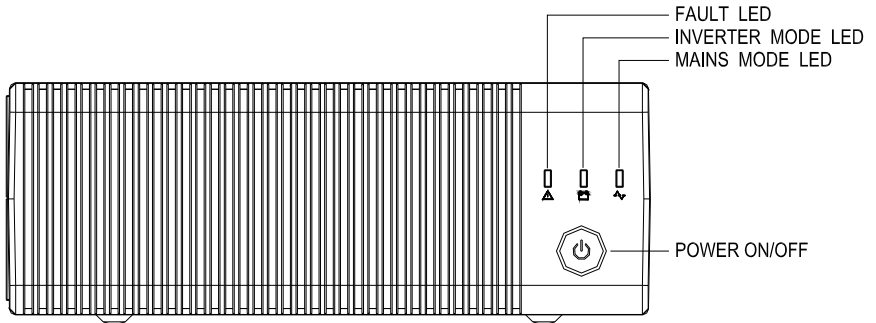

Figure 1 Front Panel

### Power On/Off

power on/off button is shown as above. Once Inverex has been properly installed and batteries are connected, press this button and Inverex will turn on automatically, and works in mains mode or inverter mode according to input AC source's status. When press this button again, Inverex will turn off automatically.

### Mains Mode LED

The green LED will blink or light steadily when power mains is normal. Note: The green LED blinks every 2 seconds to indicate that battery capacity is not full enough and battery is being charged by high rate.

### Inverter Mode LED

The Yellow LED will light when power mains is abnormal. And unit will work in inverter mode.

### Fault LED

The red LED will light when fault occurs.

## Back Panel Description

Shown below are the components on the back of Inverex.

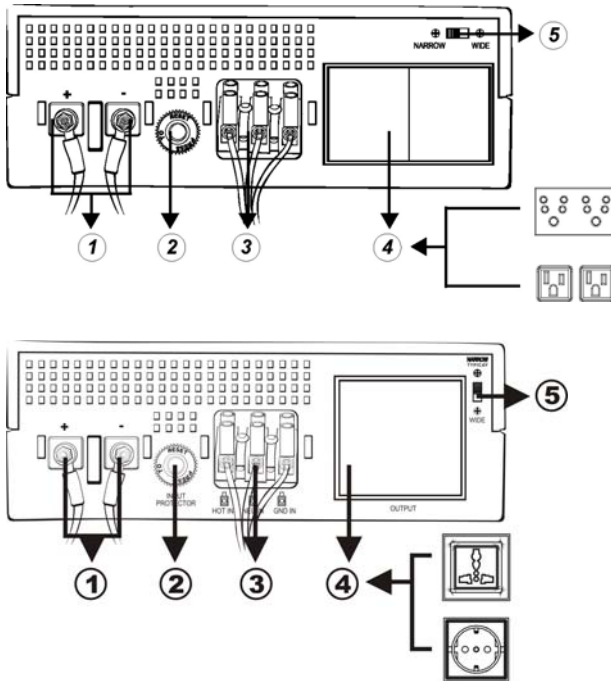

Figure 2 Back Panel

1. DC Input Connector (Battery Terminal)
2. Input Breaker
3. AC Input Connector (Three-station Terminal Block)
4. Output Receptacle(s)
5. Input Voltage Range Selector : (Input voltage range is defined in specification chapter, and output voltage is the same as input voltage in mains mode)
  - A. Select '**Narrow**' setting for general electrical appliance: If you select this mode, the Inverex operating voltage in Line mode is within

170~280Vac (90~145Vac) with the same output voltage. The line sensitivity is higher. Hence, you can connect the computer systems or other precision home equipment when you select this mode.

B. Select **'Wide'** setting to save energy: If you select this mode, the Inverex operating voltage in Line mode will be extended within 90~280Vac (50~145Vac) with the same output voltage. The Inverex is with the lower line sensitivity. Moreover, there will be taking a long transfer time when the Inverex transfer from Normal mode to Battery mode during power failure. Hence, you can connect the home equipments, such as light bulb, fan, fluorescent tube, or TV when you select this mode.

**Caution!!** If you select the **'Wide'** mode and connect the computer to the output of Inverex, the computer may reboot if the input voltage is too low to be accepted. In addition, the long transfer time will happen when power failure makes the computer reboot.

## Battery Connection

**Step 1-** Pinch the bottom of DC input cover and Open it. See Figure 4.

**Step 2-** Following battery polarity guide located near battery terminal! Place the battery cable ring terminal over Inverex's battery terminal. Tighten the M5 nut. Do not place anything between the flat part of battery terminal and the battery cable ring terminal, or overheating may occur.

**Caution!** DO NOT place anything between battery cable ring terminals and battery terminals. The terminal stud is not designed to carry current. Apply Anti-oxidant paste to terminals after terminals have been torqued.

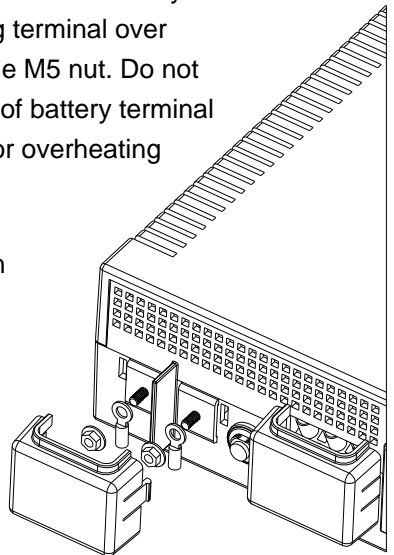
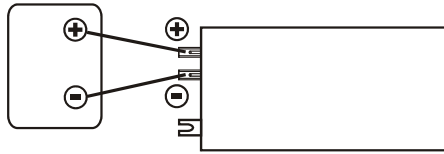

Figure 4 Battery Cable Connection to Inverex

### Step 3- Connect battery cables to your batteries

- Single battery connection: When using a single battery, its voltage must be equal to the voltage of Inverex Nominal Input Voltage  
(Apply to Inverex 500/1000)



- For the user operation safety, we strongly recommend that you should isolate the battery terminals before you start to operate the unit. Please refer to below instruction for further information. If you parallel more batteries to extend the backup time, please make sure that you already use tapes to isolate the rest battery terminals before you start to operate the unit.

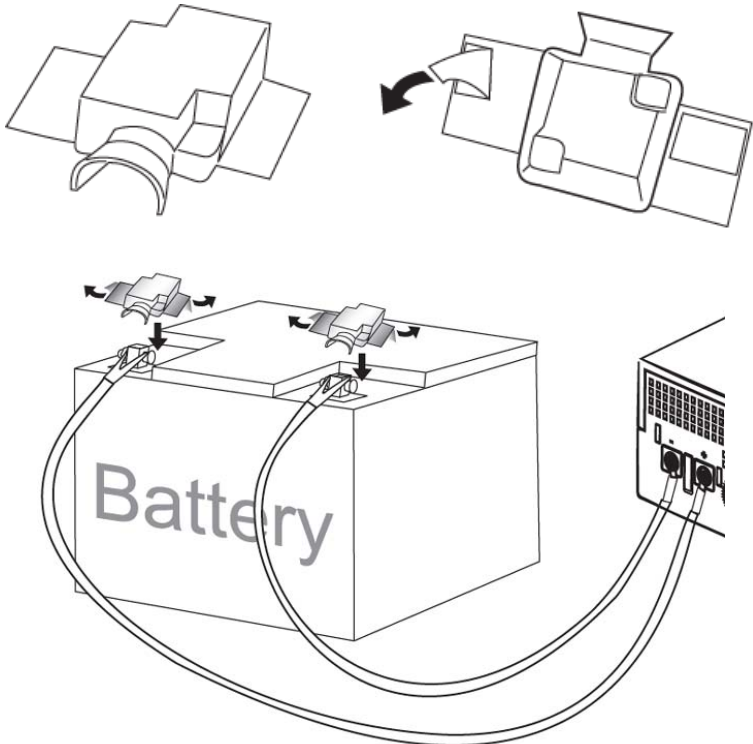

- Series battery connection: When using multiple batteries in series, all batteries must be equal in voltage and amp hour capacity, and the sum of their voltages must be equal to the voltage of Inverex Nominal Input Voltage (Apply to Inverex 1000/1500/2000)

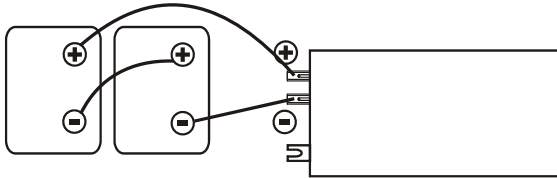

- Parallel battery connection: When using multiple batteries in parallel, each battery's voltage must be equal to the voltage of Inverex Nominal Input Voltage (Apply to Inverex 500/1000 extend the backup time)

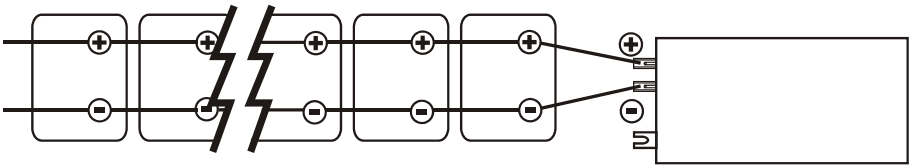

# AC Connection

Before having AC connection, match the power requirements of connected devices with the power output of Inverex to avoid overload. Consult a qualified electrician, and follow local code for the proper wire sizes, connectors and conduit requirements.

Step 1- A three-station terminal block is provided to make AC input connections. Remove the cover plate.

**Caution!!** Be sure that AC source is disconnected before attempting to connect AC to Inverex.

**Step 2-** Connect the hot wire (black/brown) of AC input cable to the HOT IN terminal.

**Step 3-** Connect the neutral wire (white/blue) of AC input cable to the NEU IN terminal

**Step 4-** Connect the ground wire (green) of AC input cable to the GND IN terminal

**Step 5-** Tighten screws to affix wires in terminal block.

**Step 6-** Cover up the AC Input by the plastic cover.

**Step 7-** Simply plug your equipment(s) into the output receptacle(s).

**Step 8-** Turn on Inverex when you are using connected equipment(s).

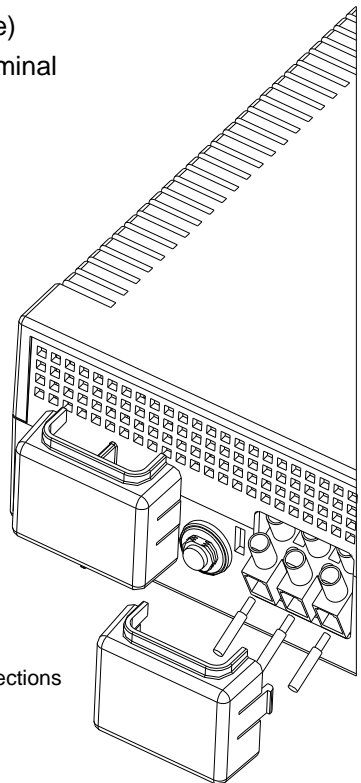

Figure 5 AC Input Connections

# Troubleshooting

Problem	Possible Cause	Remedy
No LED display	1. Battery Weak	1. Re-charge battery cable and DC input connection.
	2. Battery defect	2. Battery replacement.
	3. Power switch is not pressed	3. Press and hold power switch.
Mains normal but works in inverter mode	1. AC Input is missing	1. Check AC input connection.
	2. Input protector is effective	2. Reset the input protector.
Alarm buzzer beeps continuously	1. Overload	1. Verify that the load matches the capability specified in the specs.
Back up time is shorten	1. Overload	1. Remove some non-critical load.
	2. Battery voltage is too low.	2. Charge battery for 8 hours or more.

If any abnormal situations occur that are not listed above, please call service people immediately.

# Specification

MODEL		INVEREX 500	INVEREX 1000	INVEREX 1500	INVEREX 2000	INVEREX 1000
<b>CAPACITY</b>	VA/W	500VA/300W	1000VA/600W	1500VA/900W	2000VA/1200W	1000VA/600W
<b>INPUT</b>	Nominal Voltage	110/120VAC or 220/230/240VAC				
	Voltage Range	90-145VAC or 170-280VAC (Narrow Range)				
		50-145VAC or 90-280VAC (Wide Range)				
<b>OUTPUT</b>	Voltage	120VAC or 230VAC				
	Voltage Regulation(Batt. Mode)	+10% / -18%				
	Frequency	50Hz or 60Hz				
	Frequency Regulation (Batt. Mode)	+/-0.1 Hz				
	Output Waveform	Modified Sine-wave				
<b>BATTERY &amp; CHARGER</b>	Charger Current	8 Amp +/- 1Amp	10 Amp +/- 1Amp	10 Amp +/- 1Amp	10 Amp +/- 1Amp	6A +/-1Amp
	DC Voltage	12V +/- 0.2V	12V +/- 0.2V	24V +/- 0.4V	24V +/- 0.4V	24V +/- 0.4V
	Overcharge Protection	14.5V +/- 0.3V charger stops and fault			29V +/- 0.6V charger stops and fault	
<b>TRANSFER TIME</b>	Typical	8ms Typical				15-20ms Typical
<b>EFFICIENCY</b>	AC to AC	>95%				
	DC to AC	>80%				
<b>INDICATOR</b>	AC Mode	Green lighting				
	Battery Mode	Yellow lighting				
	Battery Charging Mode	Green flashing every 2 seconds				
	Overload	Red flashing every 0.5 second				
	Fault	Red lighting				
<b>AUDIBLE ALARM</b>	Low Battery at Battery Mode	Sounding every 2 seconds				
	Overload	Sounding every 0.5 second				
	Fault	Continuously sounding				
<b>PROTECTION</b>	Full Protection	Discharge, overcharge, and overload protection				
<b>PHYSICAL</b>	Dimension (DxWxH) mm	224 X 255 X 80				
	Net Weight (kgs)	2.0	2.3	2.5		
<b>ENVIRONMENT</b>	Operating Environment	0- 40°C, 0-90 % relative humidity (non-condensing)				
	Noise Level	Less than 55dB				

\* Product specifications are subject to change without further notice